

**CATHOLIC HIGH SCHOOL**  
**PRELIMINARY EXAMINATION (2024)**  
**PRIMARY SIX**  
**MATHEMATICS**  
**PAPER 1**  
**(BOOKLET A)**

Name . \_\_\_\_\_ ( )

Class : Primary 6 \_\_\_\_\_

Date : 20 August 2024

Total time for Booklet A and B : 1 hour

15 questions

20 marks

Parent's signature : \_\_\_\_\_

**INSTRUCTIONS TO CANDIDATES**

Do not turn over this page until you are told to do so.

Follow all instructions carefully.

Answer all questions.

Shade your answers in the Optical Answer Sheet (OAS) provided.

The use of calculators is **NOT** allowed.

This booklet consists of 9 printed pages and 1 blank page.

Questions 1 to 10 carry 1 mark each. Questions 11 to 15 carry 2 marks each. For each question, four options are given. One of them is the correct answer. Make your choice (1, 2, 3 or 4). Shade the oval (1, 2, 3 or 4) on the Optical Answer Sheet. All diagrams are not drawn to scale. (20 marks)

---

1. Which of the following is the same as 5080 cm?

- (1) 5 m 8 m
  - (2) 5 m 80 cm
  - (3) 50 m 8 cm
  - (4) 50 m 80 cm
- 

2. How many sevenths are there in  $2\frac{4}{7}$ ?

- (1) 13
  - (2) 15
  - (3) 18
  - (4) 24
- 

3. What is a possible volume of hot water that fills a disposable cup completely?

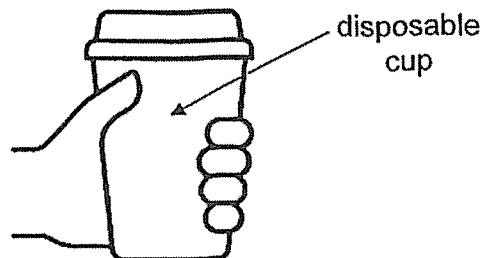

- (1) 32 m<sup>3</sup>
  - (2) 32 cm<sup>3</sup>
  - (3) 320 m<sup>3</sup>
  - (4) 320 cm<sup>3</sup>
-

4. The figure below shows a cube.



Which of the following is a net of the cube?

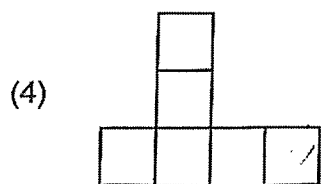
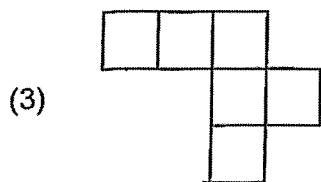
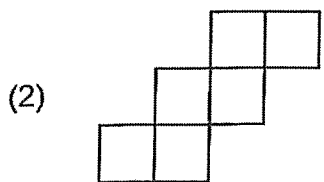
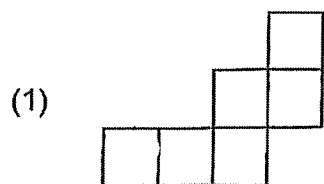

5. Which two lines are perpendicular to each other?

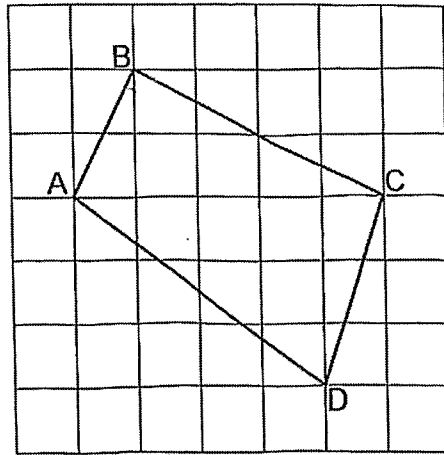

- (1) AB and BC
- (2) BC and AD
- (3) CD and AB
- (4) CD and AD

---

6. What is the mass of the packet of flour?

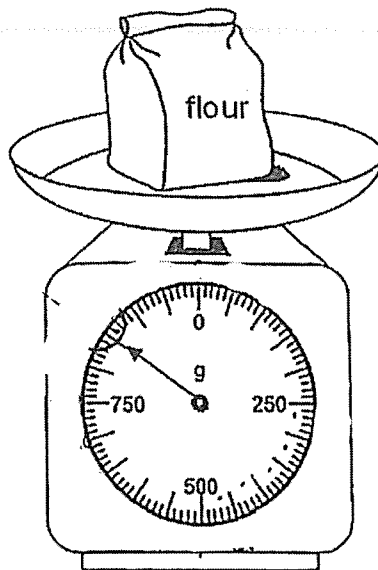

- (1) 760 g
- (2) 800 g
- (3) 850 g
- (4) 950 g

7. Which of the following decimal is the smallest?

- (1) 0.110
- (2) 0.200
- (3) 0.003
- (4) 0.040

---

8. The line graph shows the amount of rainfall over 5 months. The amount of rainfall is not shown on the scale.

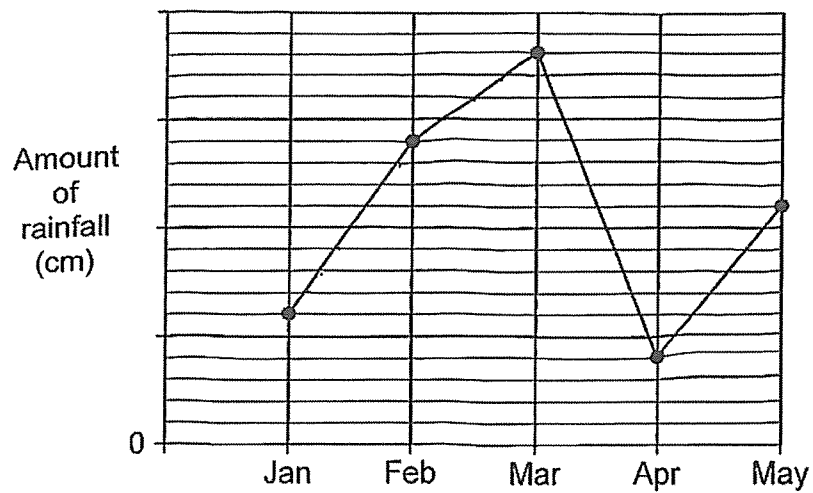

From which month to the next was the increase in rainfall the greatest?

- (1) From Jan to Feb
- (2) From Feb to Mar
- (3) From Mar to Apr
- (4) From Apr to May

9. Charles and Denny started running a marathon at 5.20 a.m. Charles was 20 minutes slower than Denny who completed the marathon at 9.05 a.m. How long did Charles take to complete the marathon?

- (1) 3 h 25 min
  - (2) 4 h 5 min
  - (3) 3 h 55 min
  - (4) 4 h 35 min
- 

10. In a school, the ratio of the number of boys to the number of girls is 1 : 2. The pie charts show the different ways boys and girls go to school.

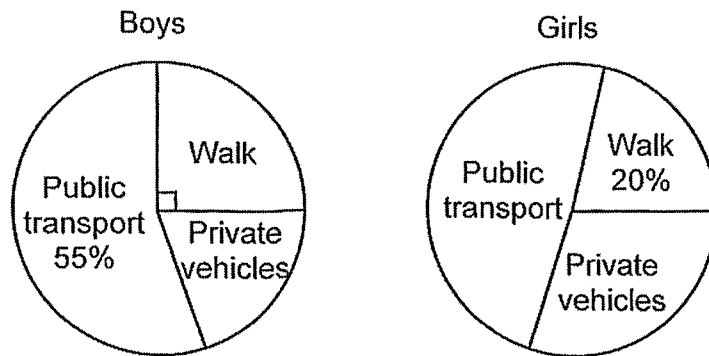

What is the ratio of the number of boys who walk to school to the number of girls who walk to school?

- (1) 4 : 5
  - (2) 5 : 4
  - (3) 8 : 5
  - (4) 5 : 8
-

11. In the figure, ABCD is a square.  $AD = DF$  and  $\angle ADF = 58^\circ$ . Find  $\angle BEF$ .

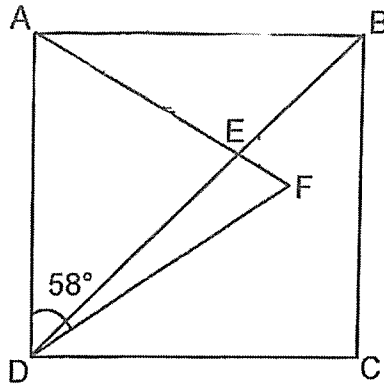

- (1)  $71^\circ$   
(2)  $74^\circ$   
(3)  $106^\circ$   
(4)  $109^\circ$
- 
12. Ivan had 30 fewer sweets than Peggy at first. After he gave some of his sweets to Peggy, he was left with 28 sweets. Peggy had 3 times as many sweets as Ivan in the end. How many sweets did Ivan give to Peggy?
- (1) 13  
(2) 26  
(3) 27  
(4) 54
-

13. Figure 1 shows a rectangular paper. It is folded along the dotted line AB to form Figure 2.

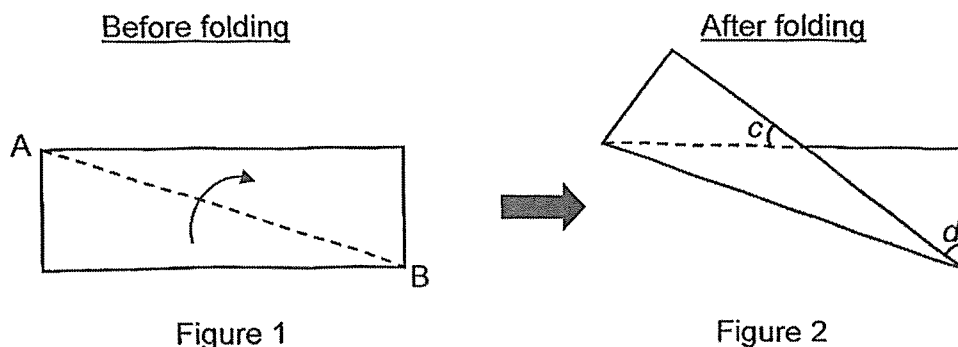

Which of the following statement(s) is/are true?

Statement A :  $\angle c + \angle d = 90^\circ$

Statement B : The area of Figure 1 is less than the area of Figure 2.

Statement C : Both Figure 1 and Figure 2 have at least a line of symmetry.

- (1) A only  
 (2) B only  
 (3) A and C only  
 (4) B and C only
- 
14. The figure is made up of two identical quarter circles and a square. The length of the square is 7 cm. What is the perimeter of the figure?

Take  $\pi = \frac{22}{7}$

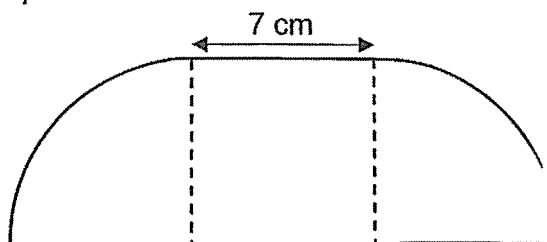

- (1) 39 cm  
 (2) 50 cm  
 (3) 72 cm  
 (4) 126 cm



15. Mrs Lim bought some pears and oranges and packed them into two bags.  $\frac{3}{4}$  of the fruits were in bag A and the rest in bag B.  $\frac{4}{9}$  of the fruits in bag A were pears.  $\frac{1}{2}$  of the fruits bought were oranges. What fraction of the fruits in bag B were pears?

(1)  $\frac{1}{4}$

(2)  $\frac{1}{6}$

(3)  $\frac{5}{9}$

(4)  $\frac{2}{3}$

---

END OF BOOKLET A

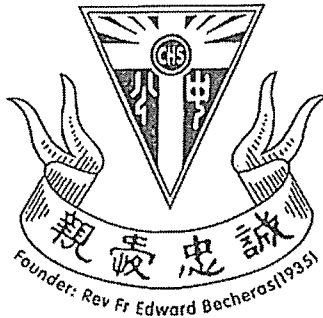

**CATHOLIC HIGH SCHOOL**  
**PRELIMINARY EXAMINATION (2024)**  
**PRIMARY SIX**  
**MATHEMATICS**  
**PAPER 1**  
**(BOOKLET B)**

Name : \_\_\_\_\_ (       )

Class : Primary 6 \_\_\_\_\_

Date : 20 August 2024

Total time for Booklet A and B : 1 hour

15 questions

25 marks

Parent's signature : \_\_\_\_\_

BOOKLET A	20
BOOKLET B	25
<b>Total Marks</b>	<b>45</b>

**INSTRUCTIONS TO CANDIDATES**

Do not turn over this page until you are told to do so.

Follow all instructions carefully.

Answer all questions.

Write your answers in this booklet.

The use of calculators is **NOT** allowed.

This booklet consists of 9 printed pages and 1 blank page.

Questions 16 to 20 carry 1 mark each. Write your answers in the spaces provided. For questions which require units, give your answers in the units stated. All diagrams are not drawn to scale. (5 marks)

Do not write  
in this space

16. Round 12 976 to the nearest hundred.

Ans: \_\_\_\_\_

17. Find the value of  $2.34 \times 60$

2

Ans: \_\_\_\_\_

18. Find the value of  $\frac{4}{7} \div 14$

Give your answer as a fraction in the simplest form.

Ans: \_\_\_\_\_

19. Find the value of  $\frac{10w}{5} - w + 1$  when  $w = 4$ .

Do not write  
in this space

Ans: \_\_\_\_\_

20. Write down all the common factors of 8 and 12.

Ans: \_\_\_\_\_

**Total marks for questions 16 to 20**

Questions 21 to 30 carry 2 marks each. Show your working clearly and write your answers in the spaces provided. For questions which require units, give your answers in the units stated. All diagrams are not drawn to scale.

Do not write  
in this space

(20 marks)

21. Use all the digits 6, 5, 0, 8 to form

(a) the greatest multiple of 5.

Ans: \_\_\_\_\_

(b) the number closest to 6000.

Ans: \_\_\_\_\_

22. Jessie had a total of thirty 20¢ and 10¢ coins. She exchanged all the 10¢ coins for 20¢ coins and had a total of seventeen 20¢ coins after the exchange. How many 10¢ coins did she have at first?

Ans: \_\_\_\_\_

23. Find the area of the shaded triangle.

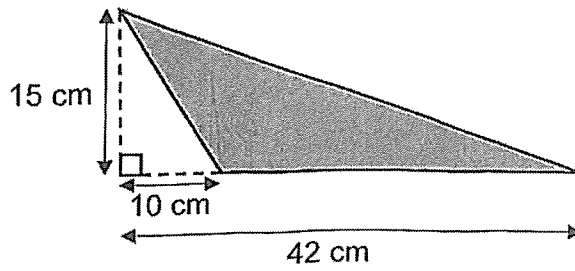

Do not write  
in this space

Ans: \_\_\_\_\_  $\text{cm}^2$



24. A rhombus ABCD is on a square grid.  
(a) Using the line RS, draw a square PQRS such that it has the same perimeter as ABCD.

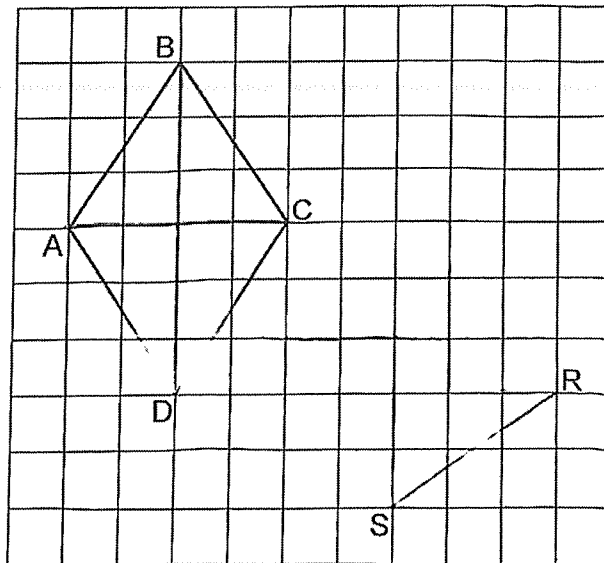

- (b) What fraction of the area of rhombus ABCD is the area of square PQRS?

Ans: (b) \_\_\_\_\_

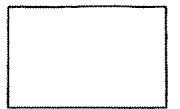

25. In 1 minute, Machine A can pack 5 boxes of cookies while Machine B can pack 2 boxes of cookies. Both machines started packing at 12.50 a.m. At what time will both machines pack 175 boxes of cookies in total? Leave your answer in 24-hour clock.

Do not write  
in this space

Ans: \_\_\_\_\_

26. The airmail rates to a country are shown in the table below.

First 20 g	? ¢
Every additional 10 g or less	12 ¢

Quentin sent a letter that weighed 33 g. He paid 56 ¢. How much did Quentin pay for the first 20 g of the letter?

Ans: \_\_\_\_\_ ¢

27. Gregory glued 9 unit cubes together to form the solid shown.

Do not write  
in this space

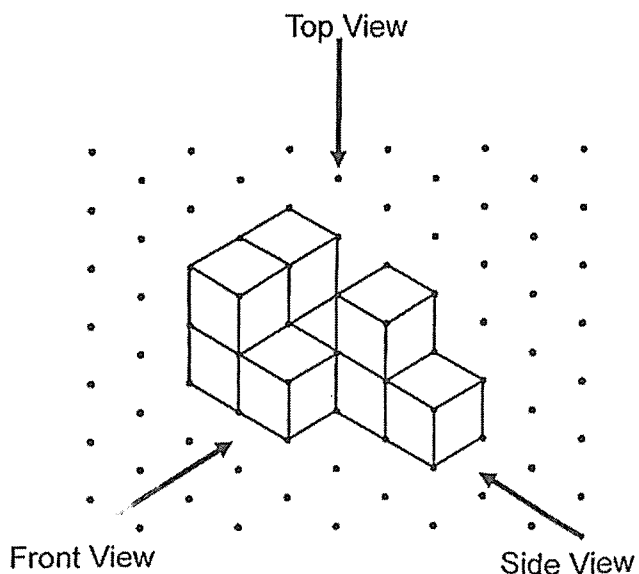

(a) Draw the top view on the grid.

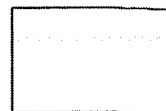
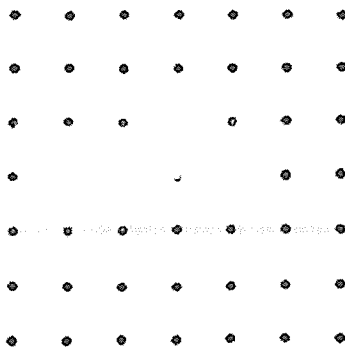

(b) Gregory glued more unit cubes to the above solid to form a cube.  
What was the least number of unit cubes used by Gregory?

Ans: \_\_\_\_\_





28. 40 pupils helped to sell packets of popcorn at a school carnival. Each pupil was given 6 packets of popcorn to sell. Some pupils did not turn up, so each pupil present had to sell 2 more packets of popcorn to meet the required sale. How many pupils did not turn up?

Do not write  
in this space

Ans: \_\_\_\_\_

29. A box contains beads of three different colours.  $\frac{3}{5}$  of the beads are red and the rest are blue beads and green beads. The ratio of the number of blue beads to that of green beads is 2 : 3. What percentage of the beads is blue?

Ans: \_\_\_\_\_%

30. A bakery had a number of cakes for sale. After selling 42 cakes in the morning and  $\frac{4}{9}$  of the remainder in the afternoon, it was left with  $\frac{1}{3}$  of the cakes. How many cakes were left?

Do not write  
in this space

Ans: \_\_\_\_\_

Total marks for questions 21 to 30

END OF BOOKLET B  
END OF PAPER 1

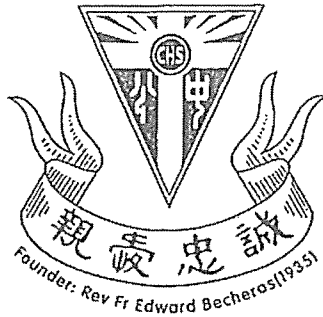

**CATHOLIC HIGH SCHOOL**  
**PRELIMINARY EXAMINATION (2024)**  
**PRIMARY SIX**  
**MATHEMATICS**  
**PAPER 2**

Name : \_\_\_\_\_ ( )

Class : Primary 6 \_\_\_\_\_

Date : 20 August 2024

Total time : 1 hour 30 min

17 questions

55 marks

Parent's signature : \_\_\_\_\_

PAPER 1 BOOKLET A	20
PAPER 1 BOOKLET B	25
PAPER 2	55
<b>Total Marks</b>	<b>100</b>

**INSTRUCTIONS TO CANDIDATES**

Do not turn over this page until you are told to do so.

Follow all instructions carefully.

Answer all questions.

Write your answers in this booklet.

The use of an approved calculator is expected, where appropriate.

This booklet consists of 17 printed pages and 1 blank page.

Questions 1 to 5 carry 2 marks each. Show your working clearly in the space below each question and write your answers in the spaces provided. For questions which require units, give your answers in the units stated. All diagrams are not drawn to scale.

Do not write in this space

(10 marks)

1. The square grid shows the position of points A, B, C, D, E, F and G.

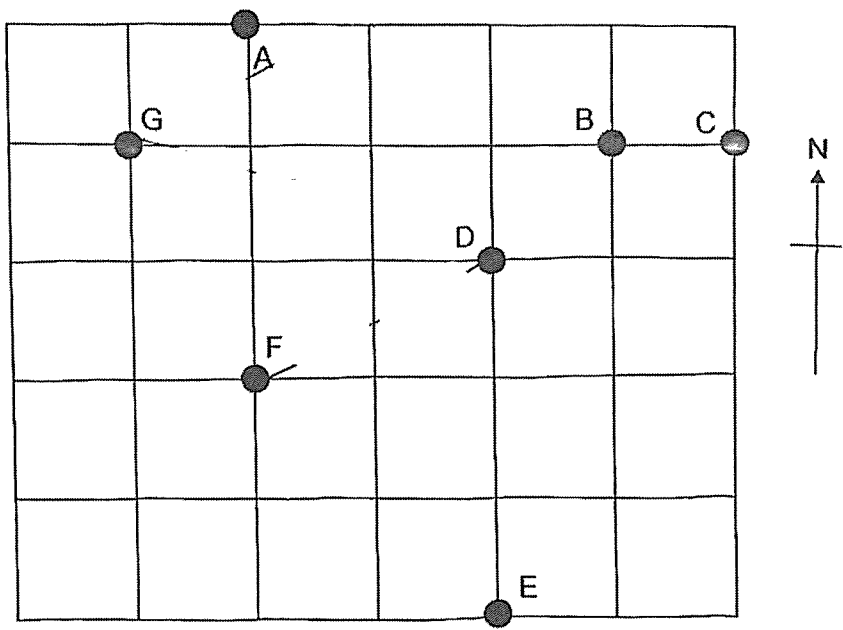

(a) Which point is east of point B?

Ans: (a) Point \_\_\_\_\_

(b) Elisha stood at one of the points facing point D. After she turned 45° clockwise, she faced point F. Which point was Elisha standing?

Ans: (b) Point \_\_\_\_\_

2.

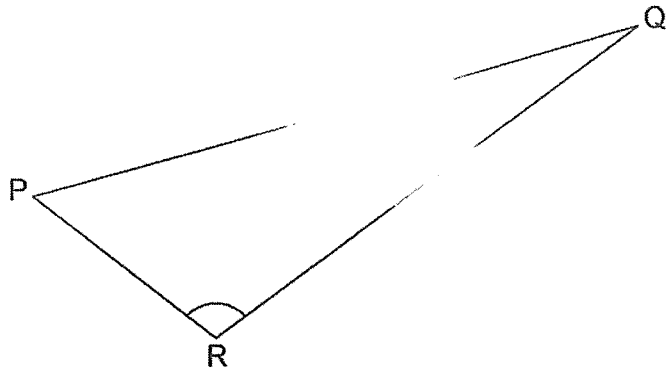

Measure and write down

(a) the length of PQ to the nearest 0.1 cm.

Ans: (a) \_\_\_\_\_ cm

(b) the size of  $\angle PRQ$

Ans: (b) \_\_\_\_\_ °

3. The ratio of the length of stick W to the length of stick Y is 9 : 8. Find the length of stick W.

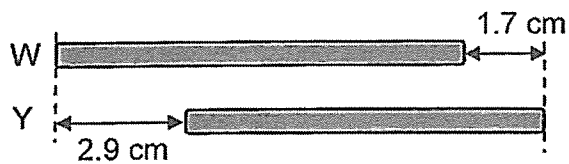

Ans: \_\_\_\_\_ cm

Do not write  
in this space

4. Terry used 1-cm cubes to form a cuboid measuring 45 cm by 30 cm by 20 cm. He painted all the faces of the cuboid. How many of the 1-cm cubes in the cuboid have only 2 of the faces painted?

Do not write  
in this space

Ans: \_\_\_\_\_

5. Darryl has a roll of stickers. There is a total of 55 star-shaped and heart-shaped stickers on it. At least 3 star-shaped stickers are found between any 2 heart-shaped stickers. What is the largest possible number of heart-shaped stickers on the roll of stickers?

Ans: \_\_\_\_\_

For questions 6 to 17, show your working clearly in the space provided for each question and write your answers in the spaces provided. The number of marks available is shown in brackets [ ] at the end of each question or part-question. (45 marks)

Do not write in this space

6. EAD is a triangle and BCDE is a parallelogram.  $AB = BE$ . Find  $\angle EAB$ .

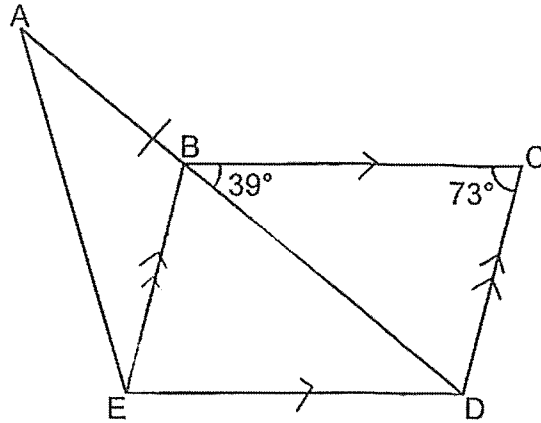

Ans: \_\_\_\_\_ [3]



7. Oliver had 130 cm of wire. He used some of it to make the figure as shown.

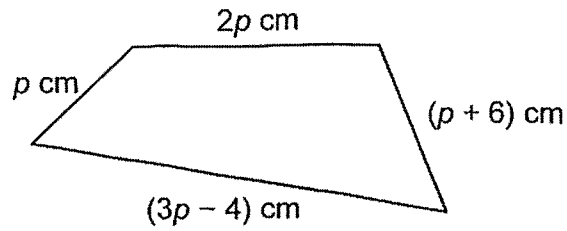

- (a) How much of the wire did Oliver use to make the figure?  
Express your answer in terms of  $p$  in the simplest form.

Ans: (a) \_\_\_\_\_ [1]

- (b) After making the figure, Oliver had  $p$  cm of wire left. What was the value of  $p$ ?

Ans: (b) \_\_\_\_\_ [2]

Do not write  
in this space



8. ABHE and BCDF are rhombuses. CGF is a straight line. Find  $\angle BGF$ .

Do not write  
in this space

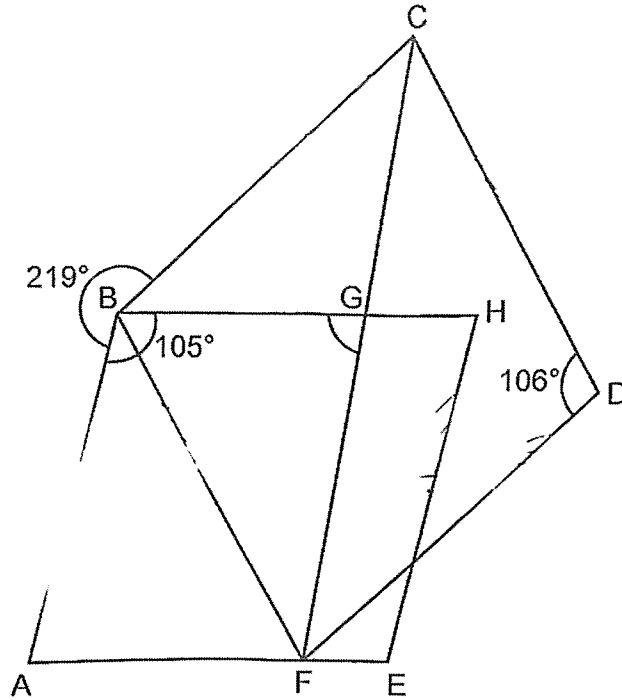

Ans: \_\_\_\_\_ [3]

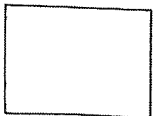

9. The bar graph below shows the types of sandwiches sold at a stall in a morning. The number of sandwiches sold is not shown on the scale.

Do not write in this space

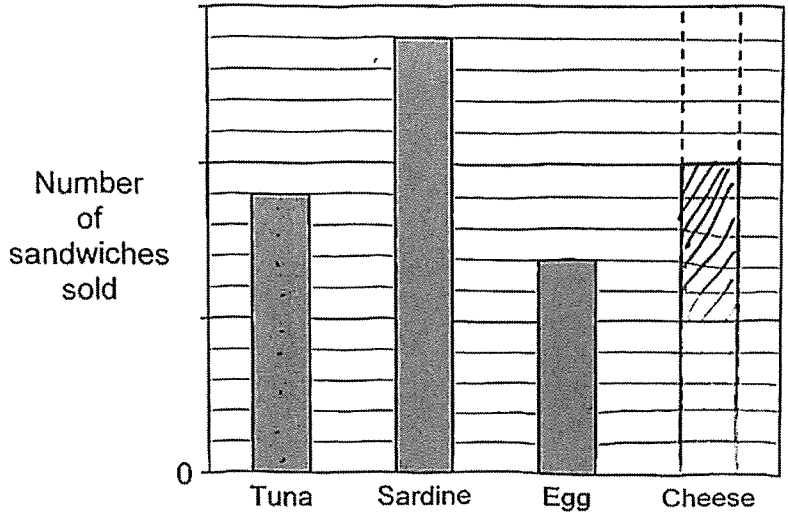

[1]

- (a) 25% of sandwiches sold in the morning was cheese. Draw the bar that shows the number of cheese sandwiches sold in the morning.

- (b) The cost of a tuna sandwich, a sardine sandwich and an egg sandwich was \$3, \$2 and \$1 respectively. A total of \$248 was collected from the sale of the 3 types of sandwiches sold in the morning. How many tuna sandwich was sold in the morning?

Ans: (b) \_\_\_\_\_ [3]

10.

Elliot and Fred started jogging at the same time from point P to point R along a 9000 m route shown. After 40 min, Fred was at the halfway point Q and Elliot was at a distance behind Fred. Fred reached point R 10 min before Elliot. Both did not change their speeds throughout.

Do not write  
in this space

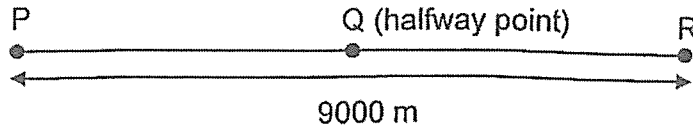

What was the distance between Elliot and Fred when Fred was at point Q?

Ans: \_\_\_\_\_ [3]



11. The first four figures of a pattern are shown below.

Do not write  
in this space

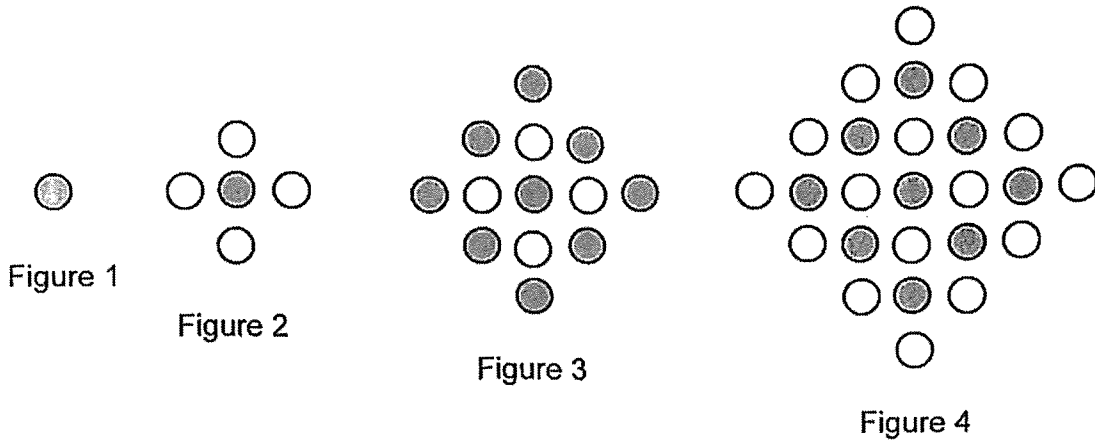

The table below shows the number of grey and white circles used for each figure.

Figure Number	1	2	3	4	5
Number of grey circles	1	1	9	9	
Number of white circles	0	4	4	16	

[1]

(a) Fill in the table for Figure 5.

(b) What is the total number of grey and white circles in Figure 250?

Ans: (b) \_\_\_\_\_ [2]

12.

Figure 1 shows 4 identical right-angled triangles. Figure 2 is formed from these triangles.

Do not write in this space

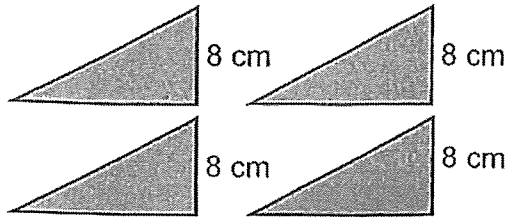

Figure 1

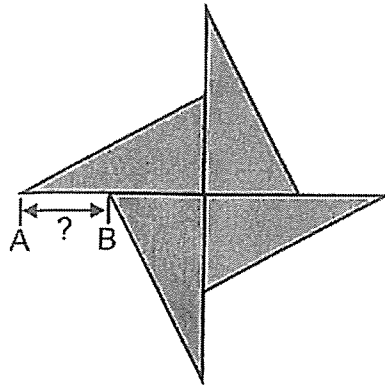

Figure 2

- (a) The total perimeter of the 4 triangles in Figure 1 is 160 cm. What is the perimeter of Figure 2?

Ans: (a) \_\_\_\_\_ [2]

- (b) The area of Figure 2 is  $240 \text{ cm}^2$ . What is the length of AB?

Ans: (b) \_\_\_\_\_ [2]

13.

Joshua received an amount of pocket money from his parents each month. Within each month, Joshua spent some of the pocket money that he received for that month and deposited the remaining money into a savings box.

Do not write  
in this space

The graphs below show the amount of money he spent and the remaining money he deposited into a savings box in each month.

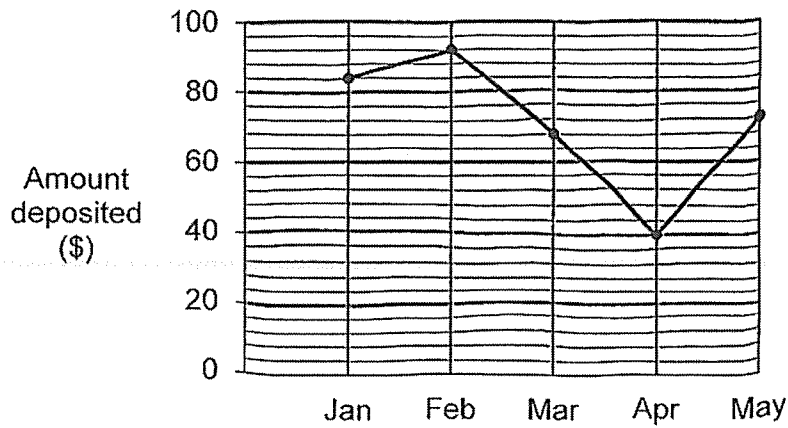
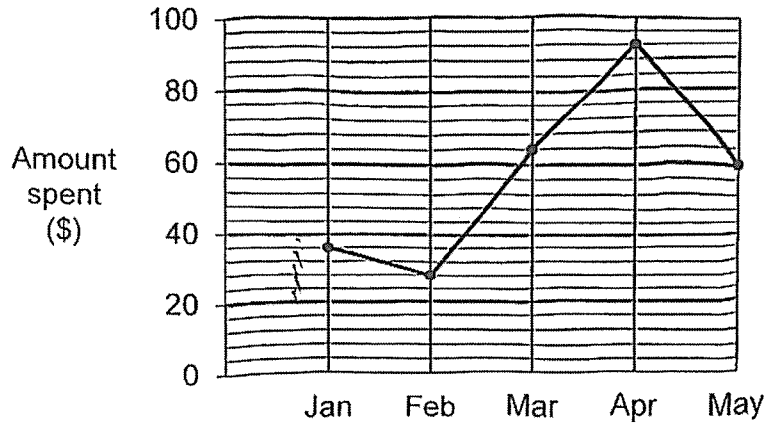

Continued from page 12 for question 13,

Do not write  
in this space

- (a) From which month onwards was there an increase in Joshua's monthly pocket money?

Ans: \_\_\_\_\_ [1]

- (b) What was the percentage increase in Joshua's monthly pocket money?

Ans: \_\_\_\_\_ [2]

- (c) In one of the months, the amount of money Joshua spent was more than the amount of money he deposited. In that month, how much more money was spent than deposited?

Ans: \_\_\_\_\_ [1]

14. Raj had an empty rectangular tank P and a cubical tank Q. He poured an equal amount of water into the tanks. After that,  $\frac{1}{4}$  of tank P was filled with water and  $\frac{2}{3}$  of tank Q was filled with water. The difference in capacity between tank P and tank Q was  $5625 \text{ cm}^3$ .

Do not write  
in this space

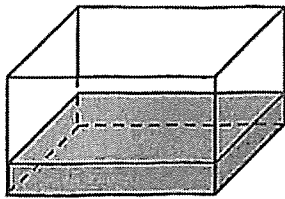

P

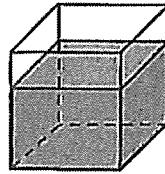

Q

- (a) What was the ratio of the capacity of tank P to tank Q?

Ans: (a) \_\_\_\_\_ [2]



- (b) What was the length of one edge of tank Q?

Ans: (b) \_\_\_\_\_ [2]





15.

The figure below is drawn on a rectangular piece of paper. Its outline consists of a large semicircle, 2 identical smaller semicircles and 2 identical quarter circles. The area of the rectangular piece of paper is  $588 \text{ cm}^2$ .

Do not write in this space

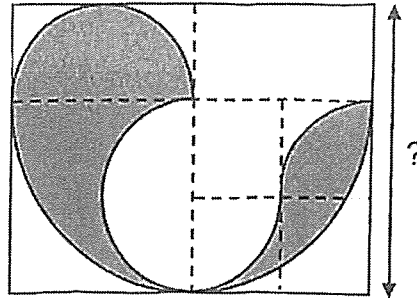

Take  $\pi = \frac{22}{7}$

(a) What is the breadth of the piece of rectangular paper?

Ans: (a) \_\_\_\_\_ [2]

(b) What is the total area of the shaded part?

Ans: (b) \_\_\_\_\_ [2]

16. Mr Lee bought a total of 38 small and big boxes of nuggets. Each small box of nuggets cost \$6.30 while each big box of nuggets cost \$9.75. He paid \$287.85 after a discount of \$4 for every \$50 spent.

Do not write  
in this space

(a) What was the total cost of the boxes of nuggets before the discount?

Ans: (a) \_\_\_\_\_ [2]

(b) How many small boxes of nuggets did Mr Lee buy?

Ans: (b) \_\_\_\_\_ [3]

17. Abel used sticks to make some stars and Brenda used sticks to make some triangles. Abel used 10 sticks to make each star while Brenda used 6 sticks to make each triangle. Abel made 7 fewer shapes than Brenda and used 10 more sticks than Brenda.

Do not write  
in this space

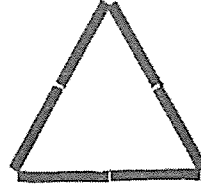
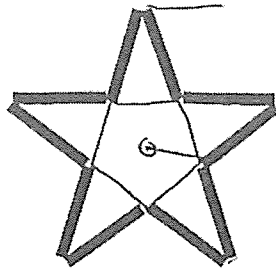

- (a) How many stars did Abel make?

Ans: (a) \_\_\_\_\_ [3]

- (b) How many sticks did Brenda use to make all her triangles?  
\_\_\_\_\_

Ans: (b) \_\_\_\_\_ [2]

END OF PAPER 2



SCHOOL : CATHOLIC HIGH PRIMARY SCHOOL  
 LEVEL : PRIMARY 6  
 SUBJECT : MATHEMATICS  
 TERM : 2024 PRELIMS

PAPER 1

BOOKLET A

Q 1	Q2	Q3	Q4	Q5	Q6	Q7	Q8	Q9	Q10
4	3	4	2	1	3	3	1	2	4
Q 11	Q12	Q13	Q14	Q15					
2	1	3	2	4					

PAPER 1

BOOKLET B

Q16	13000
Q17	$2.34 \times 60 = 140.4$
Q18	$4/7 \div 14 = 4/7 \times 1/14 = 2/49$
Q19	$10 \times 4 \div 5 - 4 + 1 = 5$
Q20	1,2,4
Q21(a)	8650
(b)	6058
Q22	$17 \times 20\text{¢} = \$3.40$ $20\text{¢} \times 30 = \$6$ $\$6 - \$3.40 = \$2.60$ $20\text{¢} - 10\text{¢} = 10\text{¢}$ $\$2.60 \div 10\text{¢} = 26$
Q23	$40 - 10 = 32$ $32 \times 15 \times \frac{1}{2} = 240\text{cm}^2$

<p><b>Q24(a)</b></p>	
<p><b>(b)</b></p>	<p><math>4 \times \frac{1}{2} \times 2 \times 3 = 12</math>  <math>12 + 1 = 13</math>  <math>13/12 = 11/12</math></p>
<p><b>Q25</b></p>	<p>0115</p>
<p><b>Q26</b></p>	<p><math>33g - 20g = 13g</math>  <math>13g \div 10g = 1R3g</math>  <math>1 + 1 = 2</math>  <math>2 \times 12\text{¢} = 24\text{¢}</math>  <math>56\text{¢} - 24\text{¢} = 32\text{¢}</math></p>
<p><b>Q27(a)</b></p>	
<p><b>(b)</b></p>	<p><math>4^3 = 64</math>  <math>64 - 9 = 55</math></p>
<p><b>Q28</b></p>	<p><math>40 \times 6 = 240</math>  <math>6 + 2 = 8</math>  <math>240 \div 8 = 30</math>  <math>40 - 30 = 10</math></p>

Q29	$2 + 3 = 5$ $2/5 \times (1 - 3/5) = 2/5 \times 2/5 = 4/25 = 16\%$
Q30	$1 - 4/9 = 5/9$ $1/3 = 5/15$ $15 - 9 = 6$ $42 \div 6 \times 5 = 35$

**PAPER 2**

**BOOKLET A**

Q1(a)	C
(b)	A
Q2(a)	8.8cm
(b)	107°
Q3	$2.9 - 1.7 = 1.2$ $1.2 \times 9 = 10.8\text{cm}$
Q4	$45 - 1 - 1 = 43$ $30 - 1 - 1 = 28$ $20 - 1 - 1 = 18$ $(43 + 28 + 18) \times 4 = 356$
Q5	$1 + 3 = 4$ $55 \div 4 = 13 \text{ R}3$ $13 \times 1 + 1 = 14$
Q6	$\angle EBD = 180^\circ - 39^\circ - 71^\circ$ $= 68^\circ$ $\angle EAB = 68^\circ \div 2 = 34^\circ$ $\angle EAB = 34^\circ$
Q7(a)	$2P + P + P + 6 + 3P - 4 = 7P + 2$ $7P + 2 \text{ cm}$
(b)	$7P + 2 + P = 130$ $8P + 2 = 130$ $130 - 2 = 8P$ $P = 16$

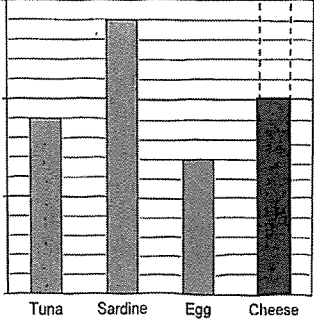
Q8	$\angle CBG = 360^\circ - 219^\circ - 105^\circ$ $= 36^\circ$ $\angle BCF = (180^\circ - 106^\circ) \div 2 = 37^\circ$ $\angle BGF = 36^\circ + 37^\circ = 73^\circ$ $\angle BGF = 73^\circ$										
Q9(a)	$9 + 14 + 7 = 30$ $100\% - 25\% = 75\%$ $30 \div 3 = 10$  <table border="1" data-bbox="363 645 678 965"> <thead> <tr> <th>Item</th> <th>Sales</th> </tr> </thead> <tbody> <tr> <td>Tuna</td> <td>9</td> </tr> <tr> <td>Sardine</td> <td>14</td> </tr> <tr> <td>Egg</td> <td>7</td> </tr> <tr> <td>Cheese</td> <td>10</td> </tr> </tbody> </table>	Item	Sales	Tuna	9	Sardine	14	Egg	7	Cheese	10
Item	Sales										
Tuna	9										
Sardine	14										
Egg	7										
Cheese	10										
(b)	$\$3 \times 9 + \$2 \times 14 + \$1 \times 7 = \$62$ $\$248 \div \$62 = 4$ $4 \times 9 = 36$										
Q10	$40 \times 2 + 10 = 90$ $9000\text{m} \div 90\text{min} = 100\text{m/min}$ $100\text{m/min} \times 40\text{min} = 4000\text{m}$ $9000\text{m} \div 2 = 4500\text{m}$ $4500\text{m} - 4000\text{m} = 500\text{m}$										
Q11(a)	<table border="1" data-bbox="438 1391 1102 1541"> <tbody> <tr> <td>Figure Number</td> <td>5</td> </tr> <tr> <td>Number of grey circles</td> <td>25</td> </tr> <tr> <td>Number of white circles</td> <td>16</td> </tr> </tbody> </table>	Figure Number	5	Number of grey circles	25	Number of white circles	16				
Figure Number	5										
Number of grey circles	25										
Number of white circles	16										
(b)	$250^2 = 62500$ $250 - 1 = 249$ $249^2 = 62001$ $62500 + 62001 = 124501$										
Q12(a)	$160 - 8 \times 8 = 96$ $96\text{cm}$										
(b)	$240 \div 4 = 60$ $(60 \times 2) \div 8 = 15$ $15 - 8 = 7\text{cm}$										



Q13(a)	$36 + 84 = 120$ $28 + 92 = 120$ $64 + 68 = 132$ $92 + 40 = 132$ $60 + 72 = 132$ / March
(b)	$132 - 120 = 12$ $12 / 120 = 10\%$
(c)	$92 - 40 = \$52$
Q14(a)	$8 : 3$
(b)	$8 - 3 = 5$ $5625 \div 5 \times 3 = 3375$ $3\sqrt{3375} = 15\text{cm}$
Q15(a)	$3u \times 4x = 588$ $12u^2 = 588$ $U^2 = 49$ $U = \sqrt{49}$ $U = 7$ $3u = 7 \times 3 = 21\text{cm}$
(b)	$7 \times 2 = 14$ $14 \times 2 = 28$ $14 \times 28 - \frac{1}{2} \times 14^2 \times \frac{22}{7} + 3 \times 7 \times 14 = 378$ $28 \times 21 - 378 = 210 \text{ cm}^2$
Q16(a)	$\$300 \div \$50 = 6$ $\$287.85 + 6 \times \$4 = \$311.85$
(b)	$38 \times \$9.75 = \$370.50$ $\$370.50 - \$311.85 = \$58.65$ $\$9.75 - \$6.30 = \$3.45$ $\$58.65 \div \$3.45 = 17$
Q17(a)	$10u - 10 = 6(u + 7)$ $10u - 10 = 6u + 42$ $10u + 6u = 42 + 10$ $4u = 52$ $U = 13$
(b)	$13 + 7 = 20$ $20 \times 6 = 120$

