

RAFFLES GIRLS' PRIMARY SCHOOL  
PRELIMINARY EXAMINATION  
PRIMARY SIX  
2024

MATHEMATICS  
PAPER 1  
(BOOKLET A)

--

Name: \_\_\_\_\_

Date: 19 August 2024

Class: P6 \_\_\_\_\_

Total Time: 1 hour

Math Teacher's Name: \_\_\_\_\_

**INSTRUCTIONS TO CANDIDATES**

1. Write your Index No. in the box at the top right hand corner.
2. Do not turn over this page until you are told to do so.
3. Follow all instructions carefully.
4. Answer all questions.
5. Use a 2B pencil to shade your answers on the Optical Answer Sheet (OAS).
6. The use of calculator is NOT allowed.

Paper 1	45
Paper 2	55
Total score out of 100	
Parent's signature	

Questions 1 to 10 carry 1 mark each. Questions 11 to 15 carry 2 marks each.  
For each question, four options are given. One of them is the correct answer.  
Make your choice (1, 2, 3 or 4). Shade your answer (1, 2, 3 or 4) on the OAS provided.  
(20 marks)

---

1.  $60\,000 + 5000 + 400 + 3 = \underline{\hspace{2cm}}$

- (1) 65 430
- (2) 65 403
- (3) 65 043
- (4) 60 543

2. What is the missing number in the box?

$$2\frac{5}{6} = \frac{\square}{6}$$

- (1) 10
- (2) 12
- (3) 17
- (4) 25

3. Which number is the largest?

- (1) 1.44<sup>o</sup>
- (2) 1.45<sup>o</sup>
- (3) 1.054
- (4) 1.405

4. What is the length of the bolt shown below?

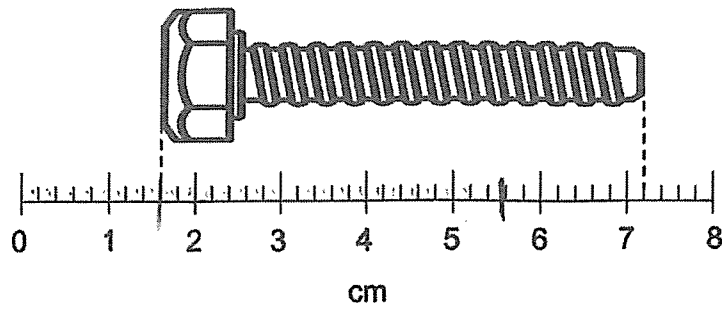

- (1) 5.6 cm
- (2) 5.8 cm
- (3) 7.1 cm
- (4) 7.2 cm

5. What is 5% of 2000?

- (1) 10
- (2) 100
- (3) 1000
- (4) 10 000

6. Which of the following shows  $\frac{1}{5}$  of the figure shaded?

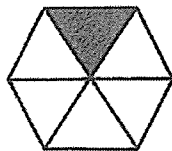

(1)

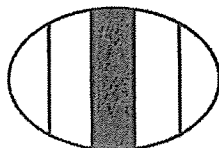

(2)



(3)

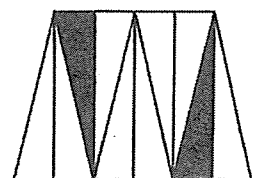

(4)

7. Which of the following is **not** a net of a cube.

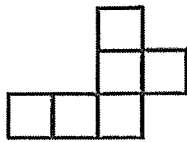

(1)

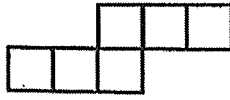

(2)

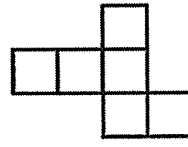

(3)

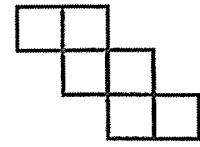

(4)

8. Arrange these distances from the longest to the shortest.

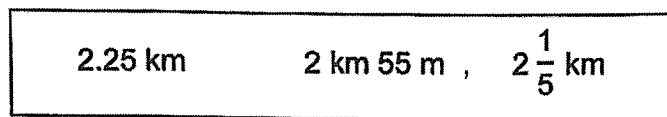

Longest

Shortest

- (1) 2 km 55 m ,  $2\frac{1}{5}$  km , 2.25 km
- (2) 2 km 55 m , 2.25 km ,  $2\frac{1}{5}$  km
- (3)  $2\frac{1}{5}$  km , 2.25 km , 2 km 55 m
- (4) 2.25 km ,  $2\frac{1}{5}$  km , 2 km 55 m

9. ACDF is a parallelogram and BED is an equilateral triangle.  $\angle AFE = 68^\circ$ . Find  $\angle BDC$ .

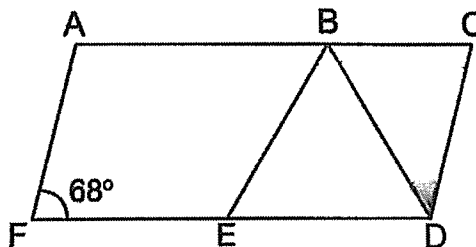

- (1)  $44^\circ$
- (2)  $52^\circ$
- (3)  $56^\circ$
- (4)  $60^\circ$

Use the information below to answer Questions 10 and 11.

10. A group of senior citizens was asked in a survey to choose one game they enjoy from Uno, Chess, Toss-a-ring and Bingo. The table represents their choices.

Game	Percentage of senior citizens
Uno	5%
Chess	15%
Toss-a-ring	25%
Bingo	?

What percentage of the senior citizens chose Chess and Bingo?

- (1) 15%
- (2) 55%
- (3) 70%
- (4) 80%
11. The choices enjoyed by the senior citizens were also represented by a pie chart but the names of the games were not shown. The number of senior citizens choosing one of the games was 30. How many senior citizens took part in the survey?

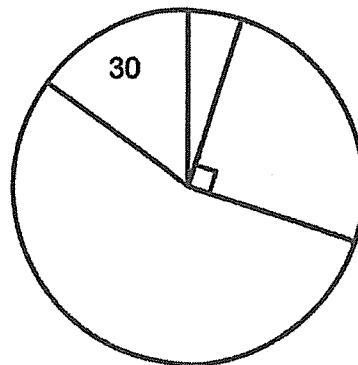

- (1) 100
- (2) 120
- (3) 200
- (4) 600

12.

Box	Number of markers	Percentage of markers which are red
A	100	6%
B	200	9%

What is the ratio of the total number of red markers in Box A and B to the total number of markers in Box A and B?

- (1) 1 : 3
- (2) 1 : 20
- (3) 2 : 3
- (4) 2 : 25

13. The figure below is made up of 6 identical rectangles. Find the area of the shaded triangle.

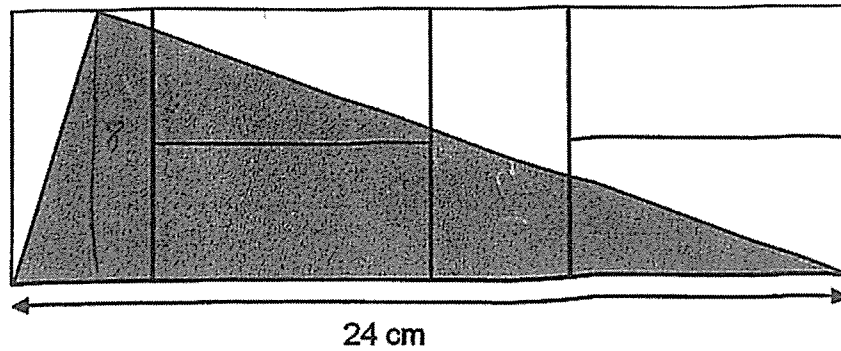

- (1) 72 cm<sup>2</sup>
- (2) 96 cm<sup>2</sup>
- (3) 144 cm<sup>2</sup>
- (4) 192 cm<sup>2</sup>

14. ABCD is a rhombus and AEC is a straight line. Find  $\angle DEC$ .

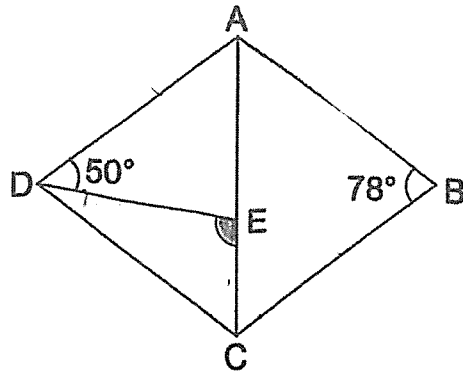

- (1)  $130^\circ$
- (2)  $113^\circ$
- (3)  $102^\circ$
- (4)  $101^\circ$

15. Figure 1 shows a parallelogram with a perimeter of 50 cm. Figure 2 is formed using 3 such parallelograms and it has a perimeter of 108 cm. Find the length of AB.

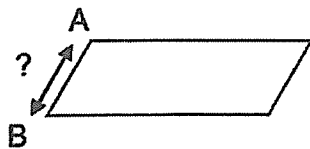

Figure 1

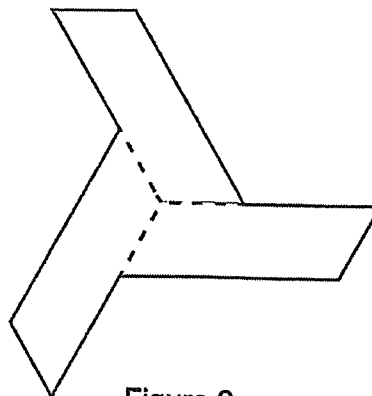
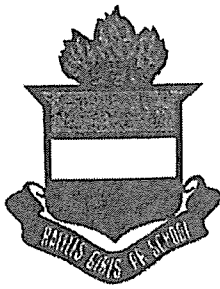

Figure 2

- (1) 7 cm
- (2) 9 cm
- (3) 14 cm
- (4) 42 cm

© Please check your work carefully ©



RAFFLES GIRLS' PRIMARY SCHOOL  
PRELIMINARY EXAMINATION  
PRIMARY SIX  
2024

MATHEMATICS  
PAPER 1  
(BOOKLET B)

Name: \_\_\_\_\_

Date: 19 August 2024

Class: P6 \_\_\_\_\_

Total Time: 1 hour

Math Teacher's Name: \_\_\_\_\_

**INSTRUCTIONS TO CANDIDATES**

1. Write your Index No. in the box at the top right hand corner.
2. Do not turn over this page until you are told to do so.
3. Follow all instructions carefully.
4. Answer all questions.
5. Use a dark blue or black ballpoint pen to write your answers in the space provided for each question.
6. Do not use correction fluid/tape or highlighters
7. The use of calculator is **NOT** allowed.



Questions 16 to 20 carry 1 mark each. Write your answers in the spaces provided.  
For questions which require units, give your answers in the units stated.

(5 marks)

16. Find the value of  $\frac{11}{12} \div 3$

Ans: \_\_\_\_\_

17. 7 lines are drawn in the square grid.

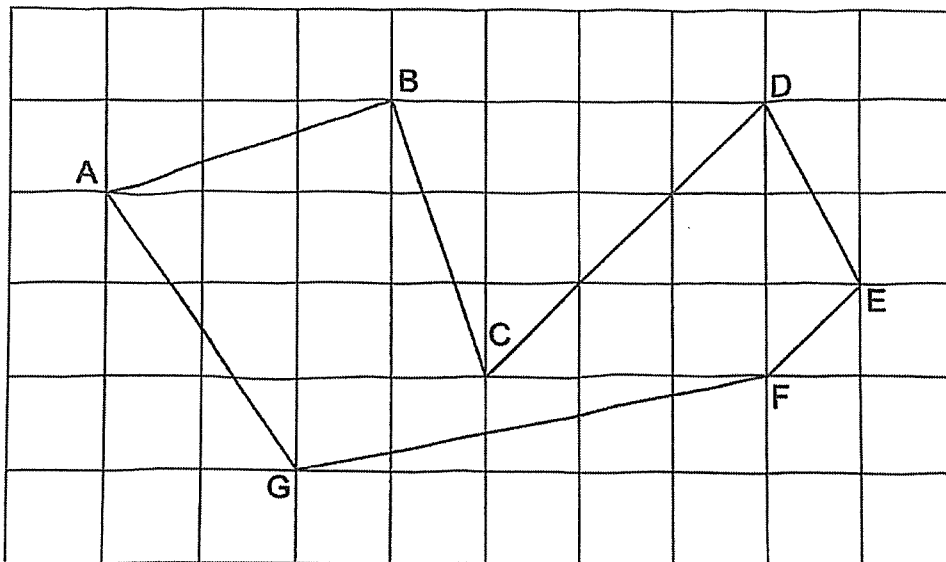

Name two lines that are parallel to each other.

Ans: \_\_\_\_\_ and \_\_\_\_\_

18. In the programme guide shown, one movie leads to another without any break in between.

Start time	Programme
5.45 pm	A Little Princess
7.20 pm	<u>Wonder</u>
9.15 pm	The Secret Garden

What is the duration of the movie "Wonder"?

Ans: \_\_\_\_\_ h \_\_\_\_\_ min

19. What is the percentage discount for the toaster shown?

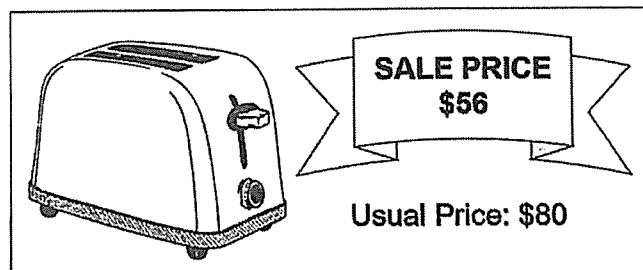

Ans: \_\_\_\_\_ %

20. The bar graph shows the number of items sold in an electrical store in a month.

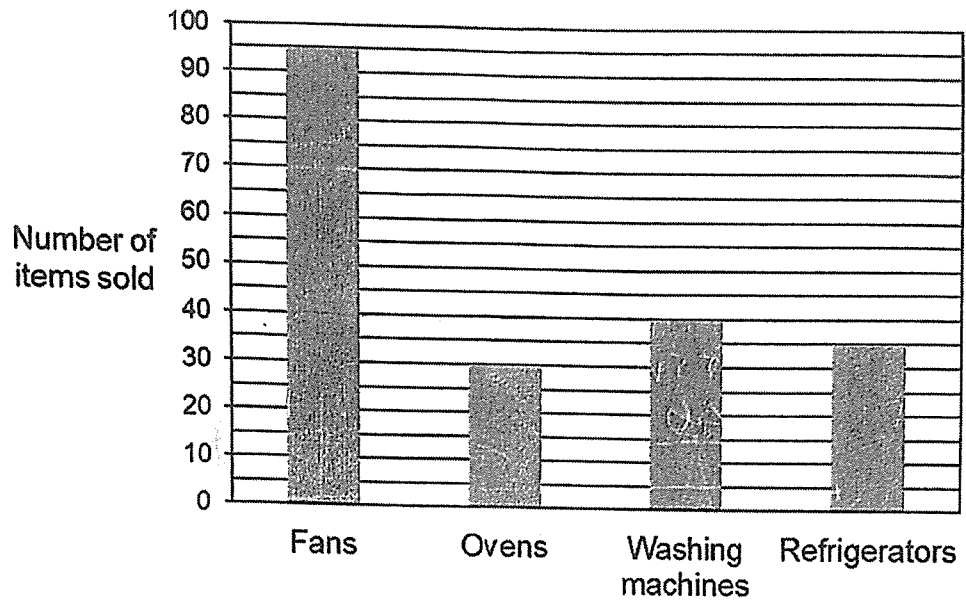

How many more fans than washing machines were sold?

Ans: \_\_\_\_\_

Questions 21 to 30 carry 2 marks each. Show your working clearly in the space provided for each question and write your answers in the space provided. For questions which require units, give your answers in the units stated.

(20 marks)

---

21. Find the value of the following when  $r = 4$ .

(a)  $9r - 2$

Ans: (a) \_\_\_\_\_

(b)  $3r - \frac{r}{9}$

Ans: (b) \_\_\_\_\_

22. (a) Round 32.047 to one decimal place.

Ans: (a) \_\_\_\_\_

(b) Write down one decimal between  $\frac{1}{10}$  and  $\frac{1}{5}$

Ans: (b) \_\_\_\_\_

23. A machine started packing snacks at 8 a.m. at the rate of 300 packets per hour. After every 8 hours, it was stopped for 2 hours. How many packets can it pack by 11 p.m. on the same day?

Ans: \_\_\_\_\_

24. A swimmer has to swim a total of 3 races in a competition. The timing for Ryan's first two races are shown in the table.

Race	Timing (min)
1 <sup>st</sup>	4.6
2 <sup>nd</sup>	4.1
3 <sup>rd</sup>	?

Ryan's average timing is 4.3 min for the 3 races. What is the timing for his 3<sup>rd</sup> race?

Ans: \_\_\_\_\_ min

25. The figure is made up of a square and 2 triangles. The area of the square is  $100 \text{ cm}^2$ . Find the shaded area of the figure.

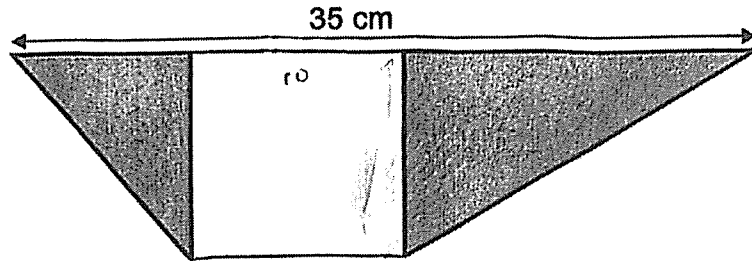

Ans: \_\_\_\_\_  $\text{cm}^2$

26. A pattern is formed using the letters B, C and D. The first 21 letters are shown.

B B C B D D B B B C B D D B B B C B D D B  
 1<sup>st</sup> 21<sup>st</sup>

The letter D appears 50 times in the pattern. What is the smallest possible number of letter B appearing in the pattern?

Ans: \_\_\_\_\_

27. There are 6 shaded shapes in the square grid. Shade the least number of shapes such that AB is the line of symmetry.

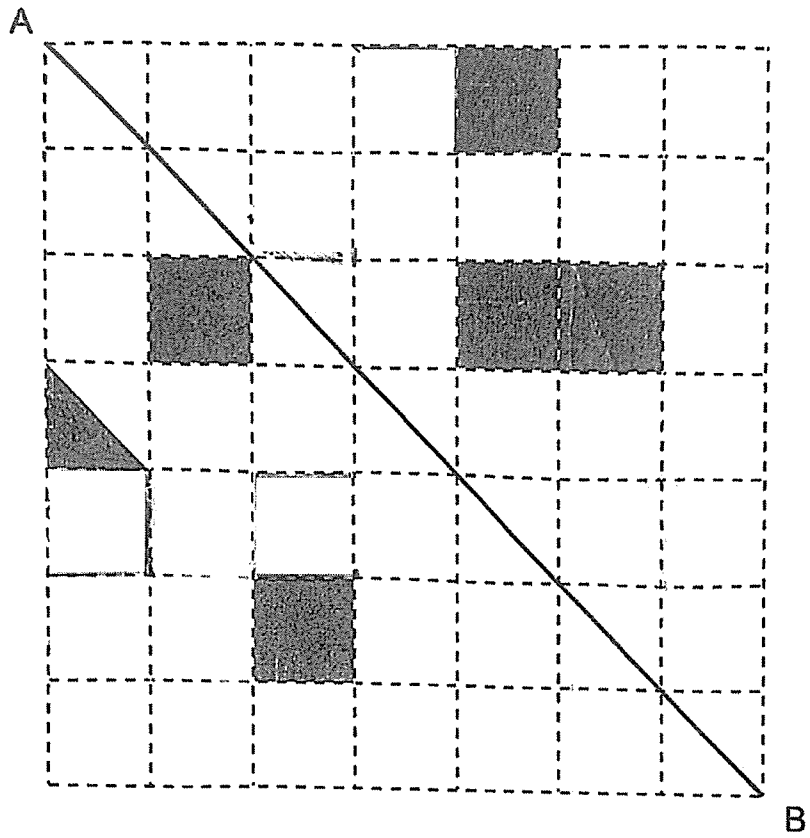

28. Bala glued 7 unit cubes to form the solid shown.

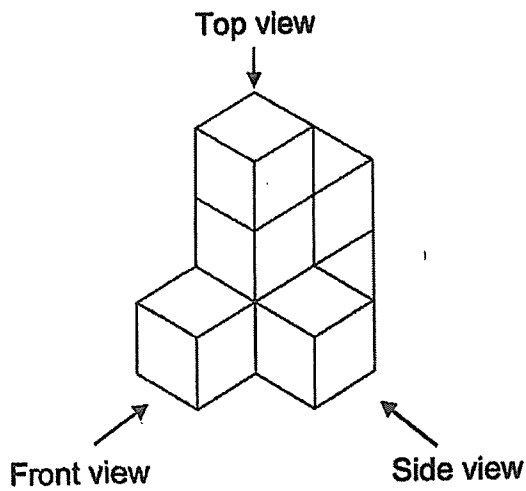

(a) Draw the side view of the solid on the grid.

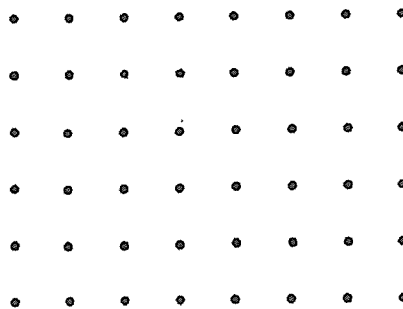

(b) Bala painted the whole solid, including the base, green. How many of the 7 cubes had exactly four of their faces painted green?

Ans: (b) \_\_\_\_\_



29. A parallelogram ABCD is drawn on a square grid. EF is one side of a triangle EFG. The sum of  $\angle EFG$  and  $\angle ADC$  is  $180^\circ$ . FG is twice as long as BC.

Draw triangle EFG on the square grid with a pencil and label it clearly.

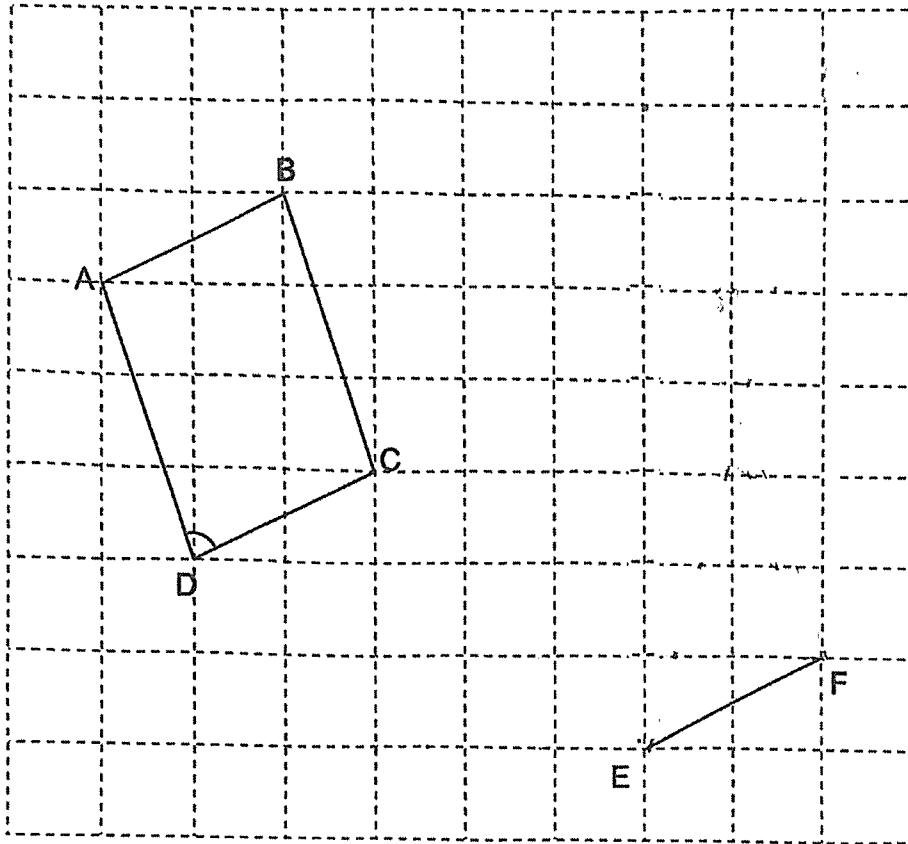

30. Aleemah had an album of local and foreign stamps in the ratio 3 : 4. She gave away an equal number of local and foreign stamps. The total number of stamps she gave away is 40. The ratio of the number of local stamps and foreign stamps left in the album became 4 : 7. How many local stamps did she have at first?

Ans: \_\_\_\_\_

**End of Paper**  
☺ Please check your work carefully ☺

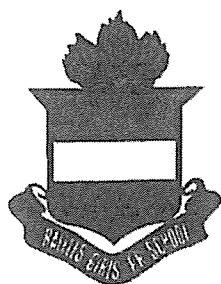

**RAFFLES GIRLS' PRIMARY SCHOOL  
PRELIMINARY EXAMINATION  
PRIMARY SIX  
2024**

**MATHEMATICS  
PAPER 2**

Name: \_\_\_\_\_

Date: 19 August 2024

Class: P6 \_\_\_\_\_

Total Time: 1 hour 30 min

Math Teacher's name: \_\_\_\_\_

**INSTRUCTIONS TO CANDIDATES**

1. Write your Index No. in the box at the top right hand corner.
2. Do not turn over this page until you are told to do so.
3. Follow all instructions carefully.
4. Answer all questions.
5. Use a dark blue or black ballpoint pen to write your answers in the space provided for each question.
6. Do not use correction fluid/tape or highlighters.
7. The use of an approved calculator is allowed.

Score	55
-------	----

Questions 1 to 5 carry 2 marks each. Show your working clearly in the space provided for each question and write your answers in the spaces provided. For questions which require units, give your answers in the units stated.

(10 marks)

1. The graph shows the total volume of water that evaporated from a container over a period of 8 h.

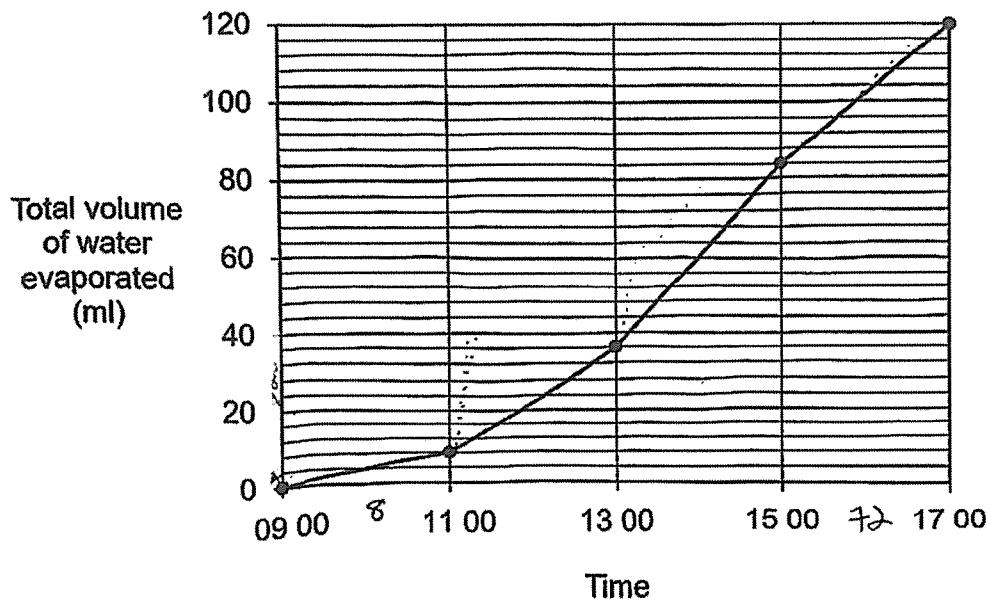

- (a) During which two-hour interval was there the most volume of water evaporated?

Ans : (a) \_\_\_\_\_ to \_\_\_\_\_ [1]

- (b) What was the total volume of water that evaporated from 11 00 to 15 00?

Ans : (b) \_\_\_\_\_ ml [1]

2. The table shows the number of books borrowed from a library by 4 friends in a month.

Name	Number of books
Amanda	5
Bala	6
Cal	30
Dewi	?

Cal borrowed half of the total number of books borrowed by his 3 friends.  
How many books did Dewi borrow?

Ans : \_\_\_\_\_ [2]

3. A car and a taxi travelled from point A to point B. When the car started the journey at 8 a.m., the taxi was 7.5 km ahead. The car travelled at 90 km/h and the taxi travelled at 75 km/h. Both went in the same direction and did not change their speeds throughout. At what time did the car and taxi pass each other?

Ans : \_\_\_\_\_ [2]

4. The pupils at a camp are divided into Group A and Group B.  $\frac{3}{8}$  of the pupils in Group A are girls.  $\frac{1}{6}$  of the pupils in Group B are girls. There are 3 times as many pupils in Group B as in Group A.

Each of the statements below is either true, false or not possible to tell from the information given. Put a tick (✓) to indicate your answer.

Statement	True	False	Not possible to tell
There are more girls in Group A than in Group B.			
The total number of boys in both groups is a multiple of 5.			
There are 32 pupils in the camp.			

[2]

5. The square grid shows the position of eight points.

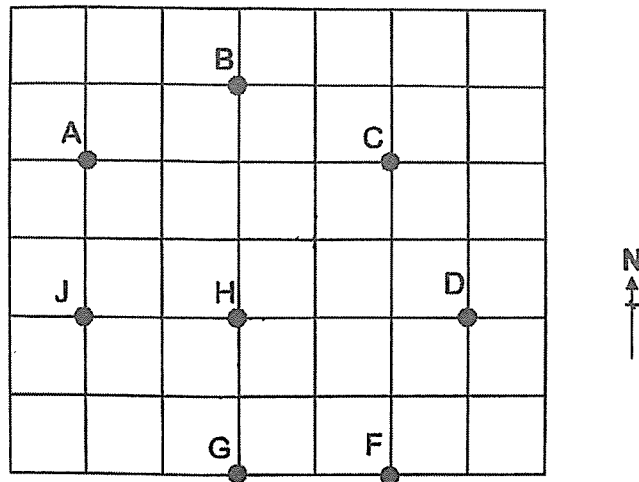

(a) Athena walked directly from point B to point D in a straight line. In which direction did Athena walk?

Ans : (a) \_\_\_\_\_ [1]

(b) Kok Ming stood at one of the points facing H. After he turned  $45^\circ$ , he faced C. Write down all the possible points where Kok Ming could be standing.

Ans : (b) \_\_\_\_\_ [1]

For questions 6 to 17, show your working clearly in the space provided for each question and write your answers in the spaces provided.  
The number of marks available is shown in the brackets [ ] at the end of each question or part-question.

(45 marks)

6. The table shows the salary Sumin was paid for working at a café.

Day	Amount
Monday to Friday	$\$3m$ per day
Saturday	$\$(5m + 8)$
Sunday	$\$(4m - 2)$

- (a) Sumin worked from Monday to Saturday in her first week. What was her total salary for the first week in terms of  $m$ ?  
Give your answer in the simplest form.

Ans: (a) \_\_\_\_\_ [1]

- (b) Sumin only worked on Saturday and Sunday in her second week. She was paid a total amount of \$240 for both days. Find the value of  $m$ .

Ans: (b) \_\_\_\_\_ [2]



7. The average height of 3 plants is 105 cm. Plant A is twice as tall as Plant B. Plant C is 0.65 m shorter than Plant A. What is the height of Plant C?

Ans : \_\_\_\_\_ [3]

8. Emily had a rectangular piece of paper. She folded it along lines BC and GF as shown. Find  $\angle FEH$ .

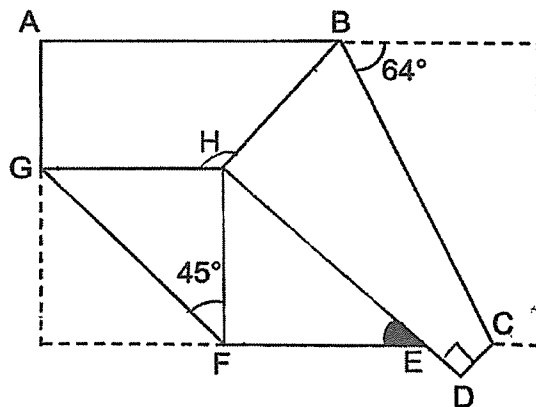

Ans: \_\_\_\_\_ [3]

9. Figure 1 shows a rectangular wooden plank of length 0.3 m. A carpenter used a number of such identical rectangular wooden planks to cover the floor of a square room. Figure 2 shows part of the arrangement. He used a total of 108 wooden planks. Find the area of the floor.

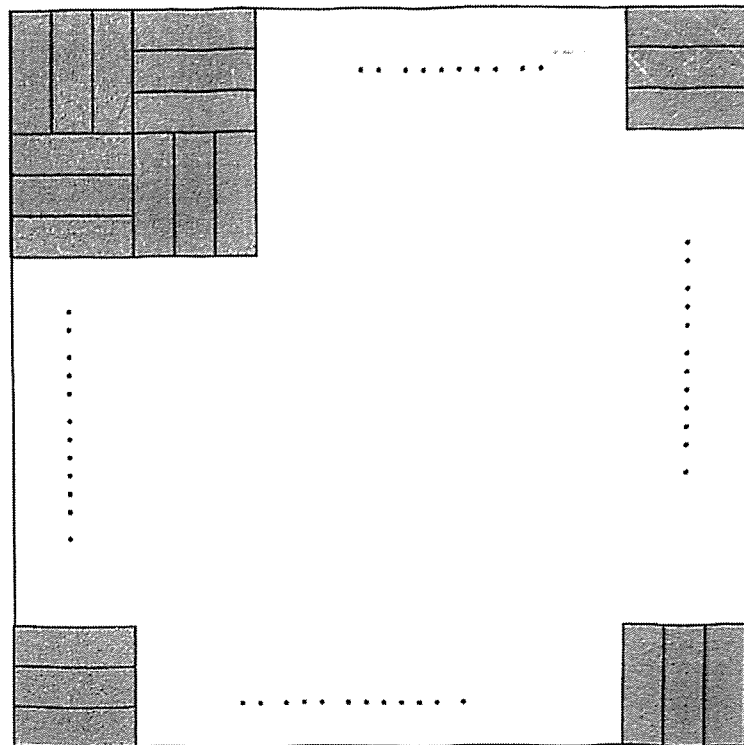
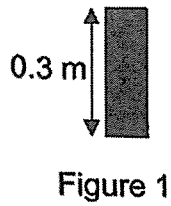

Figure 2

Ans: \_\_\_\_\_ [3]

10. Mrs Raja spent  $\frac{1}{3}$  of her money on a bag and 2 identical belts. The bag cost twice as much as each belt. Mrs Raja spent  $\frac{3}{4}$  of her remaining money on a shirt. She spent \$58 more on the shirt than on the bag. How much money did Mrs Raja have at first?

Ans : \_\_\_\_\_ [3]

11. Aminah and Serene had the same number of coins. They each had a mix of twenty-cent coins and fifty-cent coins. Aminah had 12 twenty-cent coins while Serene had 20 twenty-cent coins.

(a) Who had more money? How much more?

Ans: (a) Name of child: \_\_\_\_\_

Amount: \_\_\_\_\_ [1]

(b) Serene spent all her twenty-cent coins. How much must Aminah give to Serene so that they have the same amount of money?

Ans: (b) \_\_\_\_\_ [2]

12. ABEG and CDEF are rhombuses.  $\angle CDE = 72^\circ$ .

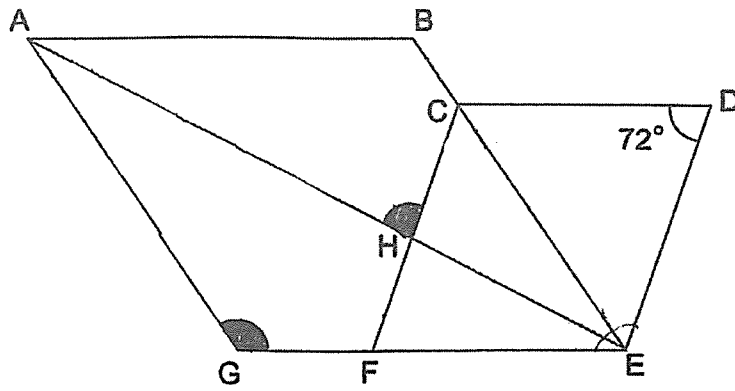

(a) Find  $\angle AGE$ .

Ans: (a) \_\_\_\_\_ [2]

(b) Find  $\angle AHC$ .

Ans: (b) \_\_\_\_\_ [2]

13. The table shows the printing rate of 4 printers. The rate for Printer D is not shown.

Printer	Number of posters per hour
A	50
B	60
C	80
D	?

The pie chart shows the total number of posters printed by each of the printers on a particular day. All the printers printed for 6 hours, except for Printer C which broke down after some time.

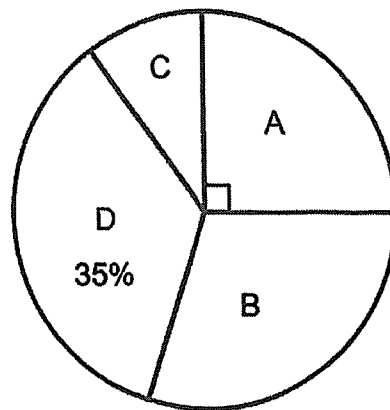

- (a) What percentage of the posters were printed by Printer B?

Ans: (a) \_\_\_\_\_ [2]

- (b) How many hours did Printer C print before breaking down?

Ans: (b) \_\_\_\_\_ [2]

14. The first four rows of numbers arranged in a certain pattern are shown.

Row 1								1							
Row 2						2	3	4							
Row 3					5	6	7	8	9						
Row 4	10	11	12	13	14	15	16								

The table shows the first number and the last number in each row for the first four rows.

Row number	First number in the row	Last number in the row
1	1	1
2	2	4
3	5	9
4	10	16
5		

[1]

(a) Complete the table for Row 5.

(b) Find the first number in Row 10.

Ans: (b) \_\_\_\_\_ [2]

(c) Find the average of the numbers in row 10.

Ans: (c) \_\_\_\_\_ [2]

15. Megan had some lilies and carnations. After she sold 75% of the lilies and  $\frac{1}{5}$  of the carnations, she had an equal number of lilies and carnations.

- (a) What was the ratio of the number of lilies to the number of carnations Megan had at first? Give your answer in the simplest form.

Ans: (a) \_\_\_\_\_ [2]

- (b) The number of lilies Megan had at first was more than 90. What was the smallest possible number of flowers Megan had at first?

Ans: (b) \_\_\_\_\_ [2]



16. Figure 1 shows the amount of water in rectangular tank P at first.

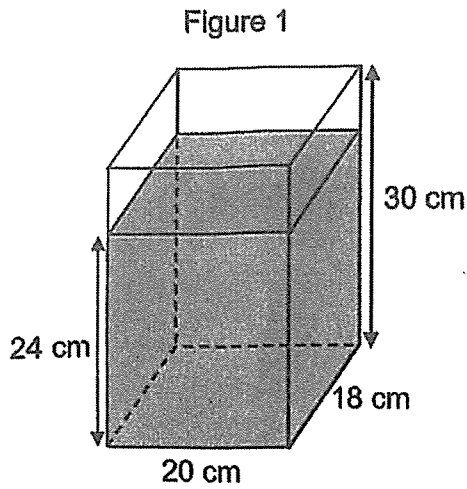

Tank P at first

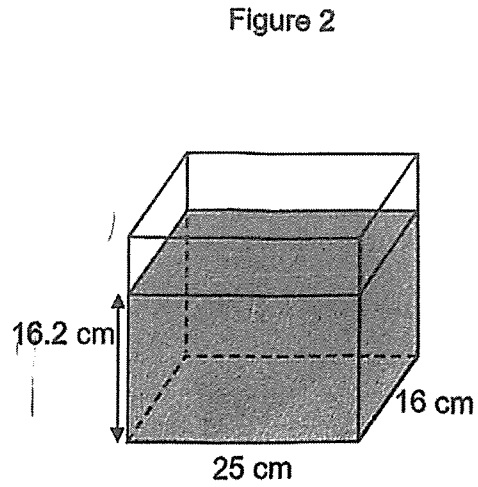

Tank Q in the end

Raj poured  $\frac{1}{3}$  of the water from tank P into tank Q. Figure 2 shows the amount of water in tank Q in the end.

(a) What was the height of the water level in Tank Q at first?

Ans: (a) \_\_\_\_\_ [3]

(b) What was the percentage increase in the volume of water in Tank Q?

Ans: (b) \_\_\_\_\_ [2]

17. The diagram shows two identical semicircles and a quarter circle as shown in Figure 1. (Take  $\pi = \frac{22}{7}$ )

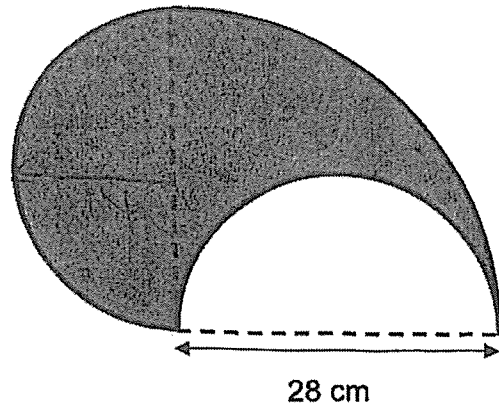

Figure 1

- (a) Find the area of the shaded figure.

Ans: (a) \_\_\_\_\_ [1]

- (b) Find the perimeter of the shaded figure.

Ans: (b) \_\_\_\_\_ [2]

- (c) 19 of such shaded figures were used to form a repeated pattern and printed at the bottom of a piece of cloth. The arrangements of the first 8 and the last 3 shaded figures on the cloth are shown in Figure 2. Find the length of the piece of cloth.

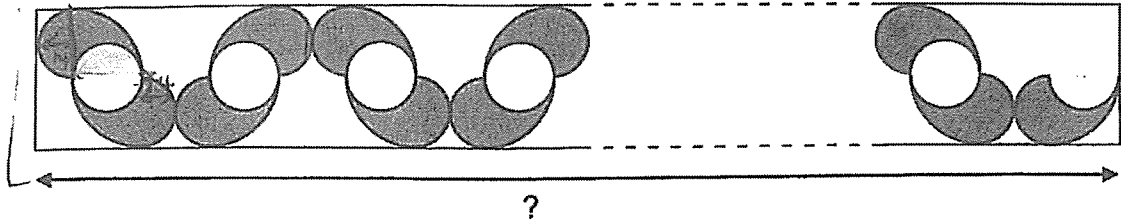

Figure 2

Ans: (c) \_\_\_\_\_ [2]

**End of Paper**  
**Please check your work carefully ☺**



SCHOOL : RAFFLES GIRLS PRIMARY SCHOOL  
 LEVEL : PRIMARY 6  
 SUBJECT : MATH  
 TERM : 2024 PRELIMS

PAPER 1 BOOKLET A

Q1	Q2	Q3	Q4	Q5	Q6	Q7	Q8	Q9	Q10
2	3	2	1	2	4	1	4	2	3

Q11	Q12	Q13	Q14	Q15
3	4	2	4	1

PAPER 1 BOOKLET B

Q16)	$\frac{11}{12} \div 3 = \frac{11}{12} \times \frac{1}{3}$ $= \frac{11}{36}$
Q17)	CD and FE
Q18)	<p>7.20                      8.15                      9.15</p> <p>= 1 hour 55 min</p>
Q19)	$\frac{24}{80} \times 100\% = \frac{3}{10}$ $= 30\%$
Q20)	$95 - 40 = 55$
Q21 - a)	$9r - 2 = 9(4) - 2$ $= 36 - 2$ $= 34$
b)	$3r - \frac{r}{9} = 3(4) - \frac{(4)}{9}$ $= 12 - \frac{4}{9}$ $= 11\frac{5}{9}$

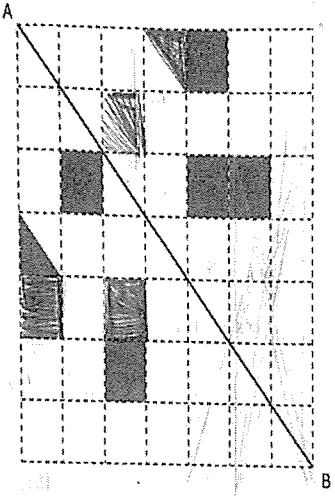
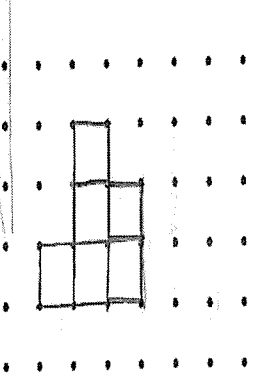
Q22 - a)	32.0
b)	0.15
Q23)	$300 \times 8 = 2400$ $300 \times 5 = 1500$ $2400 + 1500 = 3900$
Q24)	$4.3 \times 3 = 12.9$ $4.6 + 4.1 = 8.7$ $12.9 - 8.7 = 4.2 \text{ min}$
Q25)	$35 - 10 = 25$ $\frac{1}{2} \times 10 \times 25 = 125 \text{ cm}^2$
Q26)	$50 \div 2 = 25$ $25 \times 4 = 100$ $100 - 1 = 99$
Q27)	
Q28 - a)	
b)	2

Q29)

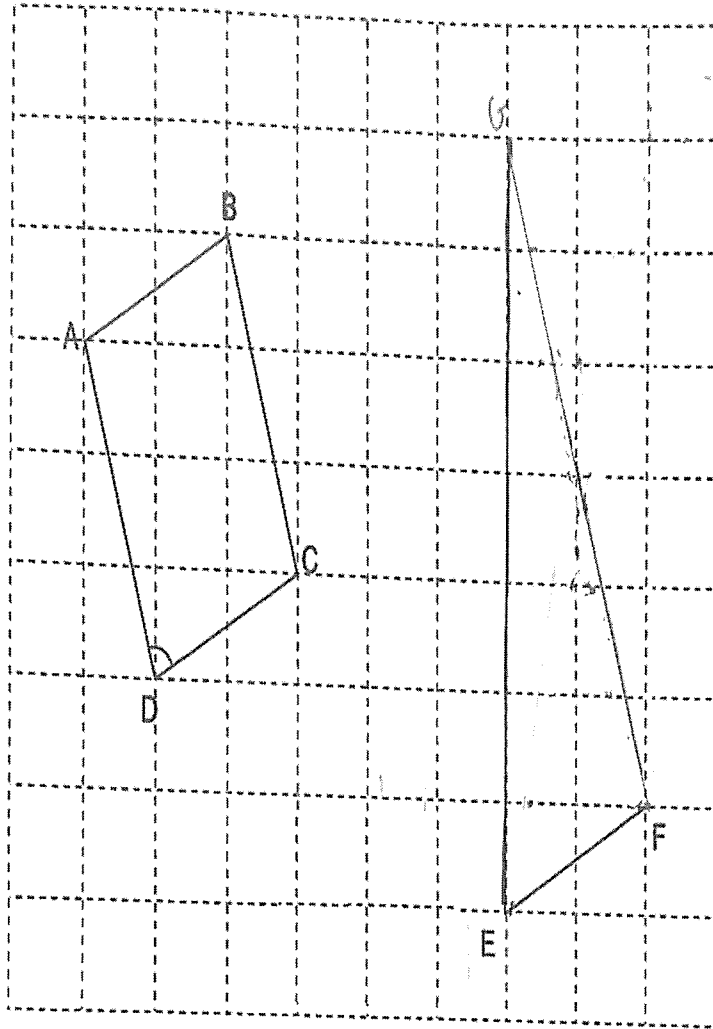

Q30)

$$\begin{aligned}9 - 4 &= 5u \\12 - 7 &= 5u \\5u &= 20 \\1u &= 4 \\9u &= 4 \times 9 = 36\end{aligned}$$

PAPER 2

Q1 - a)	1300 to 1500
b)	$28 + 48 = 76$
Q2)	$30 \times 2 = 60$ $60 - (5+6) = 49$

Q3)	8.30am																			
Q4)	<table border="1"> <thead> <tr> <th>Statement</th> <th>True</th> <th>False</th> <th>Not Possible to tell</th> </tr> </thead> <tbody> <tr> <td>There are more girls in Group A than in Group B.</td> <td></td> <td>✓</td> <td></td> </tr> <tr> <td>The total number of boys in both groups is a multiple of 5.</td> <td>✓</td> <td></td> <td></td> </tr> <tr> <td>There are 32 pupils in the camp.</td> <td></td> <td></td> <td>✓</td> </tr> </tbody> </table>				Statement	True	False	Not Possible to tell	There are more girls in Group A than in Group B.		✓		The total number of boys in both groups is a multiple of 5.	✓			There are 32 pupils in the camp.			✓
	Statement	True	False	Not Possible to tell																
	There are more girls in Group A than in Group B.		✓																	
	The total number of boys in both groups is a multiple of 5.	✓																		
There are 32 pupils in the camp.			✓																	
Q5 - a)	south-east																			
b)	A , F																			
Q6 - a)	$5 \times 3m = 15m$ $= 15m + 5m + 8$ $= 20m + 8$																			
b)	$5m + 8 + 4m - 2 = 9m + 6$ $9m + 6 = 240$ $9m = 240 - 6 = 234$ $234 \div 9 = 26$																			
Q7)	$315 + 65 = 380$ $1u = 380 \div 5 = 76$ $(2 \times 76) - 65 = 87m$																			
Q8)	$\angle GHB = 180 - 52 = 128$ $\angle FHE = 360 - 128 - 90 - 90 = 52$ $\angle FEH = 180 - 90 - 52 = 38^\circ$																			
Q9)	$\text{plank} = 0.3 \div 3 = 0.1$ $0.3 \times 0.1 = 0.03$ $108 \times 0.03 = 3.24 \text{ m}^2$																			
Q10)	$6u - 2u = 4u$ $4u = 58$ $1u = 58 \div 4$ $= 14.50$ $12u = 12 \times 14.50 = \$174$																			
Q11 - a)	$8 \times (50 - 20)\text{cents} = \$2.40$																			
b)	$12 \times 20\text{cents} = \$2.40$ $8 \times 50\text{cents} = \$4.00$ $\text{Total} = \$2.40 + \$4.00 = \$6.40$ $\$6.40 \div 2 = \$3.20$																			
Q12 - a)	$180 - 54 = 126^\circ$																			
b)	$54 \div 2 = 27$ $180 - 72 - 27 = 81^\circ$																			



Q13 - a)	$1\% \rightarrow 2$ $100\% \rightarrow 200$ $\frac{60}{200} \times 100\% = 30\%$
b)	$100 - (25+30+35) = 10$ $10\% \times 1200 = 120$ $(120 \div 80) = 1.5 \text{ hours}$
Q14 - a)	First Number in the row = 17 Last Number in the row = 25
b)	$10 \times 10 = 100$ $100 - 18 = 82$
c)	$100 - 9 = 91$
Q15 - a)	$\frac{1}{4} = \frac{4}{5}$ $\frac{4}{16} = \frac{4}{5}$ $16 : 5$
b)	$16u = 91$ $1u = 96 \div 16 = 6$ $5u = 6 \times 5 = 30$ $30 + 96 = 126$
Q16 - a)	$\frac{2880}{(25 \times 16)} = 7.2$ $16.2 - 7.2 = 9\text{cm}$
b)	$\frac{2880}{3600} \times 100\% = 80\%$
Q17 - a)	$\frac{22}{7} \times \frac{1}{2} \times 14 \times 14 = 308$ $308 + 308 = 616\text{cm}^3$
b)	$\frac{22}{7} \times \frac{1}{4} \times \frac{28}{14} \times 2 = 88$ $\frac{22}{7} \times \frac{1}{2} \times 14 \times 2 = 44$ $88 + 44 = 132\text{cm}$
c)	$14 + 28 + 14 = 56$ $(9 \times 56) + 42 = 546\text{cm}$

